

PPC-P5-150



Industrial Panel PC

Feature:

SUPPORT WINDOWS/LINUX OPERATING SYSTEMS

On-board J1900/J4105/J4125/J6412/3th/4th/6th/7th/8th/10th/11th Gen Core i3/i5/i7

Support 4G/5G Internet access function to meet communication requirements (separate module required)

Support Wifi, Bluetooth, GPS communication module (need to add a separate module)

DC12V power input

Specification:

PPC-P5-150

		PPC-P5-150	
CPU	Intel	J1900/J4105/J4125/J6412/3/4/6/7/8/10/11	
RAM	TYPE	DDR3/DDR4	
OS	WINDOWS/LINUX	WINDOWS/LINUX	
STORAGE	MSATA	1*MSATA/1*SATA	
DISPLAY	HDMI	SUPPORT 1920*1080	
	VGA	SUPPORT 1920*1080	
	USB	4*USB	
I/O	DISPLAY	1*HDMI/1*VGA	
	LAN	1*RJ45	
	CONSOLE PORT	2*RS232	
	Audio	1*Hp-out /1*Mic-in	
LCD	Display screen	15" TFT LED	
	Resolution	1024*768	
	Brightness	350cd/m2	
	Contrast	800:1	
	Maximum color	16M	
Touch	Type	Capacitive	Resistive
	Light transmittance	Above 95%	Above 85%
	Click Life	50 million times	35 million times
	Response time	<5ms	
Screen	High temperature test	85°C/1000hrs	
	Constant temperature and humidity test	85°C/90%RH/1000hrs	
Structural parameters	Panel cabinet	The casing is molded by aluminum alloy mold	
	Power input	12V DC power supply	
	Overall dimensions	370mm*290mm*57mm	
	Installation method	The panel is flush-embedded and VESA	

	Power	20W
	Weight	3kg
	Operating temperature	-20 ~ 60°C (Electronic disk)
Environment	Storage temperature	-30 ~ 80°C
parameters	Correlated humidity	10 ~ 95%@40°C (Non-condensing)
	Front panel protection	IP65 standard

Ordering Information

MODEL	SPECIFICATION
PPC-P5-150/J1900	1*LAN/4*USB/2*RS232/12V
PPC-P5-150/J4105	1*LAN/4*USB/2*RS232/12V
PPC-P5-150/J6412	1*LAN/4*USB/2*RS232/12V
PPC-P5-150/3th Gen I3	1*LAN/4*USB/2*RS232/12V
PPC-P5-150/4th Gen i3	1*LAN/4*USB/2*RS232/12V
PPC-P5-150/4th Gen I5	1*LAN/4*USB/2*RS232/12V
PPC-P5-150/4th Gen I7	1*LAN/4*USB/2*RS232/12V
PPC-P5-150/6th Gen I3	1*LAN/4*USB/2*RS232/12V
PPC-P5-150/6th Gen I5	1*LAN/4*USB/2*RS232/12V
PPC-P5-150/7th Gen I5	1*LAN/4*USB/2*RS232/12V
PPC-P5-150/7th Gen I7	1*LAN/4*USB/2*RS232/12V
PPC-P5-150/8th Gen i5	1*LAN/4*USB/2*RS232/12V
PPC-P5-150/10th Gen I3	1*LAN/4*USB/2*RS232/12V
PPC-P5-150/10th Gen I5	1*LAN/4*USB/2*RS232/12V
PPC-P5-150/10th Gen I7	1*LAN/4*USB/2*RS232/12V
PPC-P5-150/11th Gen I5	1*LAN/4*USB/2*RS232/12V

Dimensions(mm)

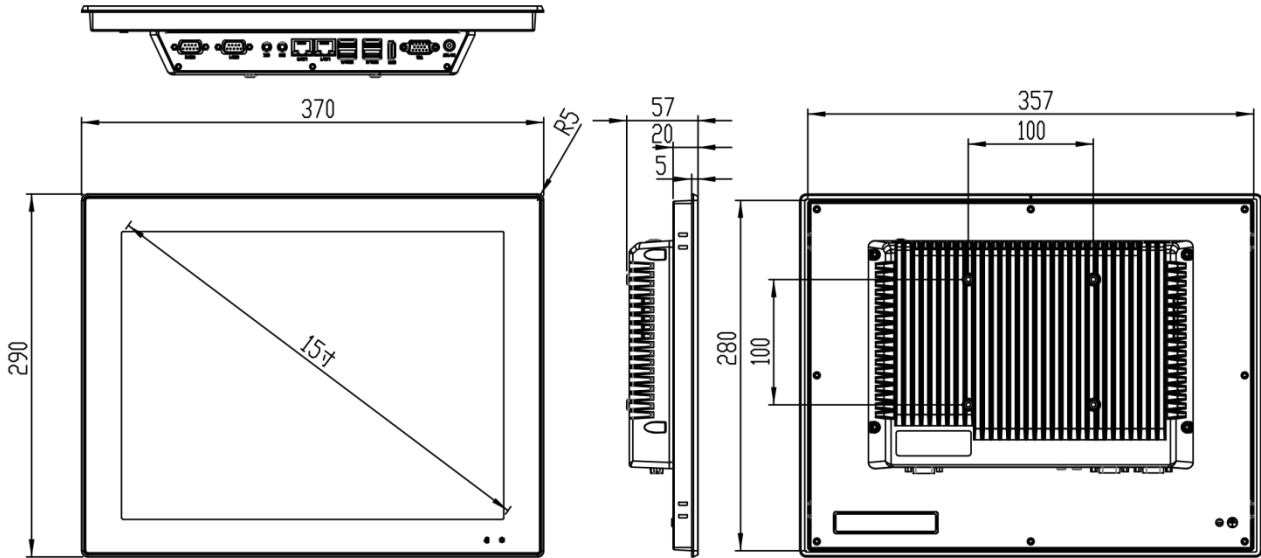

Hole size: (mm)

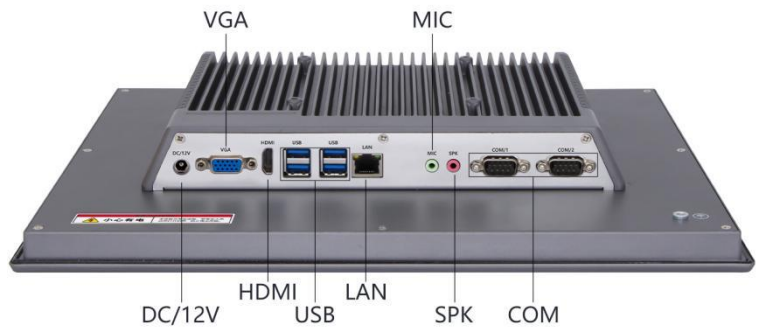
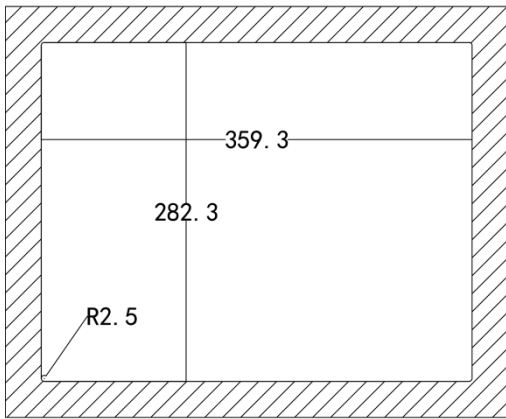

ARMORTEC

www.armortec.net

Professional industrial PC and network appliance designer and manufacturer.

Contact:

Allen Dai / Sales Manager

Armortec Technology Limited

Email: allen.y.dai@armortec.net

Skype: allen.dai89

Tel: +86 150 1266 9595